



# Beginners guide to Solar

For more information visit | [www.lgenergy.com.au](http://www.lgenergy.com.au) | [www.windsolarenergy.com.au](http://www.windsolarenergy.com.au)



# TABLE OF CONTENTS

Why You Should Choose a Solar System	3
The Benefits of Going Solar	4
How a Grid System Works	5
The Components of your Solar System	6
Solar Panels	6
Inverter Solutions	6
Mounting Systems	7
Batteries	7
Metering your Solar System	7
Measuring how your components perform. The Difference between kW and kW/H	8
Rating your Solar System	8
Installing PV Panels for your Solar System	9
Tilting and Orientation	9
Daily Routine	9
Shading	9
Mounting	10
Installing Panels for Longer-Lasting Performance	10
How Long Solar Systems Last	11
Solar Panel Sizes	12
Incentives, Rebates and Financing	13
Are There Rebates Available for Your Solar System?	13
What are STC Certificates?	13
What Are Feed in Tariffs?	13
Zero Deposit Payment Plans	13
Details on How to Choose a Solar Installer	14
Questions to Ask Before you Buy	15
Additional Tips to Avoid the Solar Sharks and Poor Quality Solar Equipment	16
The 30 LG panel advantages	18

# WHY SHOULD YOU CHOOSE SOLAR?

Over the past five years, the cost of installing a solar system has reduced. Solar energy used during the day, and soon with batteries supplying electricity at night can generate savings in your electricity bill.

Consumers of electricity who do not have solar systems are going to pay for their electricity indefinitely. In regards to electricity consumption, users are like a tenant who will keep on paying indefinitely for the accommodation. So if you invest in solar now you can get “free electricity” via solar in a few years.

By owning a solar system you own a big share of the electricity you consume, with the savings you make immediately starting to pay off the cost of your investment. For many homes in about five to six years, your power savings will have paid off the investment you spent.

With a top LG solar system you will join the hundreds of thousands of home owners across Australia and the world who have already chosen LG solar panels and you and your family will continue to save on electricity bills for years to come.



To help you select and install your solar system, a certified LG installer will guide you through the process from the moment you first consider solar panels to the planning and installation phases of your home or business solar system. You can find an installer who will supply a free detailed quote via the dealer search on the front page of [lgenergy.com.au](http://lgenergy.com.au)

# THE BENEFITS OF GOING SOLAR

So, what are the benefits of a personal solar system?

1. Solar Power can save you money – Installing Solar power enables you to generate your own electricity. By using your own electricity rather than buying it from your electricity company, you will save money as every kW/h of electricity you can use from your solar system is a kW/h of electricity you do not have to buy from your electricity company.

2. Environmental Benefits – By using electricity generated from solar panels, we reduce the need to generate electricity from fossil fuels like coal and gas which create carbon dioxide (CO<sub>2</sub>). This can reduce the potential for global warming and can create a more sustainable cleaner energy mix, as long as the solar panels will last a long time.

3. Energy Independence – By owning your own Solar system, you have the capacity to create your own electricity. This reduces your reliance on the electricity grid and electricity retailers etc and increases your control over your future electricity needs, expenses and lifestyle especially if you add batteries to your system in the future.

4. Property Value – there are increasing studies that show that installing a quality solar system on a home may increase property value. Home buyers are increasingly recognising that a home with quality solar panels installed will have lower electricity costs. <http://www.realestate.com.au/news/85-of-aussies-say-solar-panels-boost-property-prices/>

5. Energy reliability – High quality solar power systems are a reliable power source. The sun rises and sets every day, while the sun shines, solar panels will make electricity. While the weather and the seasons will vary, the amount of electricity that the panels make are predictable. You can also increase the financial benefits of your solar system by changing the times you operate your household appliances. For example, turning your washing machine on as you leave the home in the morning and avoiding washing your clothes at night allows your solar system to power your machine during the day. With the help of lithium-iron batteries, which are becoming more affordable, one can also harvest solar power during the day and use it at night.



To assess your energy usage profile and discover the benefits that you may derive from a solar system, talk to one of the LG Authorised Dealers from an LG Dealer Search on [lgenergy.com.au](http://lgenergy.com.au)

# HOW A GRID SYSTEM WORKS

A solar system is made up of multiple solar photovoltaic (PV) panels, a DC to AC power converter (inverter solution) and a framing system to hold the PV panels in place.

PV panels are generally fitted on the roof facing an northerly, easterly or westerly direction, and tilted at a particular angle to maximise the amount of sunlight that each panel receives.

Suburban homes in Australia and New Zealand are connected to the electricity grid via power lines. Our electricity system uses 240Volt alternating current (AC), but the electricity generated by solar panels consists of variable direct current (DC). To transform the DC electricity into AC electricity for ordinary household use, grid-connected solar PV systems use inverters attached to each PV panel called micro inverters or a single inverter for a string of connected PV panels called a central string inverter.

The third possible inverter solutions are power optimisers, which are a variance of the string inverter and the micro inverter. All these technical solutions can create a great solar system.

Ask your authorised LG dealer for advice on which of these inverter solutions is the most suitable for your circumstances.

Today houses with grid-connected solar systems consume solar-generated electricity first, before switching to the electricity grid if more electricity is required than the solar system was able to create.

Grid-connected solar systems can also feed electricity back to the grid if too much electricity is generated via the solar system for the immediate needs of your home. For information on rebates and rewards associated to feed-back electricity see page 13.

Unless you add storage batteries to your system, a grid-connected solar system is unable to store power in your home for use at night.

## GRID CONNECTED HOME WITHOUT BATTERIES

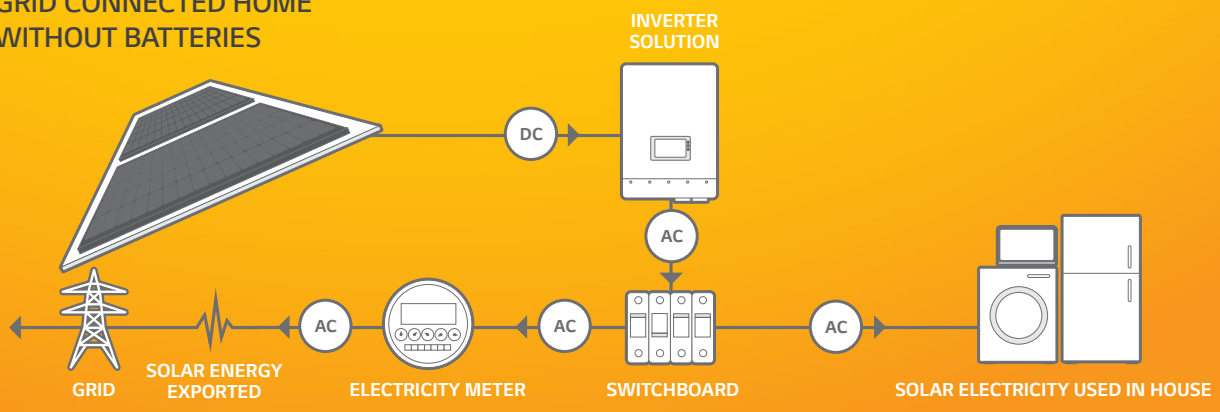

## GRID CONNECTED HOME WITH BATTERIES

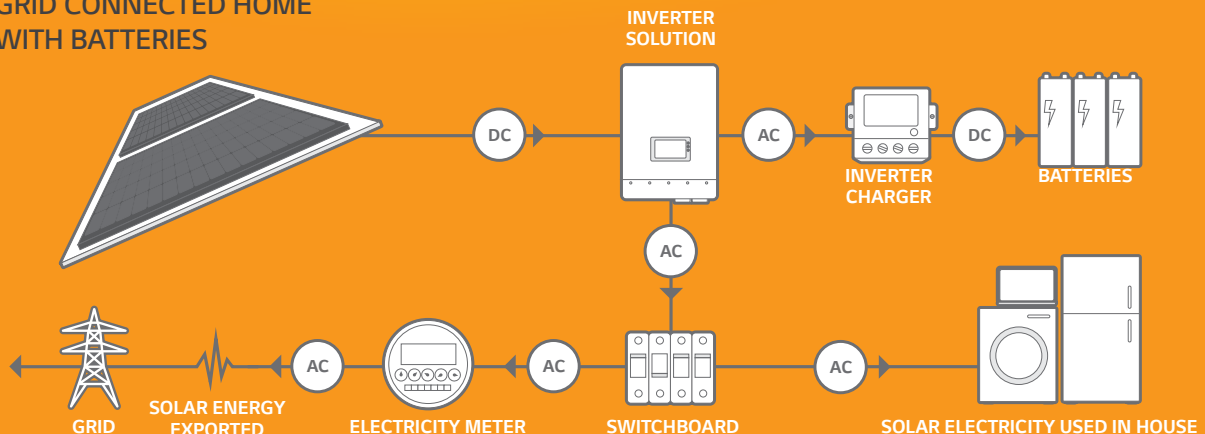

# THE COMPONENTS OF YOUR SOLAR SYSTEM

## What makes up a solar system?

A solar system is made up of a number of key components, all of which combine to generate electricity, regulate and control the flow of the electricity and to connect and mount the solar system to your building. A grid-connected solar system comprises of panels, a string inverter or micro-inverters or optimisers, a roof mounting system and electrical accessories including circuit breakers and wires. It is important that each component works together, with no component compromising the performance, safety or life expectancy of any other component.

### SOLAR PANELS

Solar PV panels on roofs of homes and businesses generate clean electricity by converting sunlight into usable electricity. This conversion takes place within the solar cells and is a process that requires no moving parts.



LG Mono X<sup>®</sup>



LG NeON<sup>™</sup> 2Black



SOLAR EDGE INVERTER



ENPHASE MICRO INVERTER



### INVERTER SOLUTIONS

A solar inverter is one of the most important elements of the solar system. It converts the variable direct current (DC) output of a photovoltaic (PV) solar panel into a 240V alternating current (AC). This AC electricity can be fed into your home to operate your household appliances.

Depending on how your system is set-up the electricity that is not used in your home is either fed into the grid via a digital meter or stored in home batteries for later use. New hybrid inverters now include an integrated battery management system.

Long lasting solar systems for the Australian climate require high quality inverters. Unfortunately, lower quality inverters and panels have failed to perform under Australian conditions in large numbers and failed in as little as 2 years.



SMA INVERTER



LG CHEM BATTERIES



ABB INVERTERS

## BATTERIES

Since 2015 solar storage batteries have reduced steadily in cost to the point that pay back is coming down from more than 10 years towards 7 years and less. In future years most residential solar systems will include a battery as part of the solar system package. Discuss with your LG panel installer if batteries are feasible in your circumstances, or if you should get a “battery ready” system.

## MOUNTING SYSTEMS

Solar systems are mounted to roofs with a mounting system using various railings, frames and tiles or tin feet. Most mounting systems are made of aluminium with stainless steel hardware and are designed to accept a variety of solar modules on a variety of roof types. Aluminium rails with clamps attach the solar panels to the rail and connection brackets fix the rail to the roof (see diagram below).

Superior mounting systems are manufactured with higher grades of aluminium and stainless steel, often resulting in less weight on the roof and lower levels of corrosion over longer periods of time. Quality mounting rails may also feature robust anchoring points and design solutions that speed-up the installation time of your solar system.

Purchasing a strong and well-engineered mounting system is the sensible way to protect the investment you have made in your solar system as they will be more rigid. It is also advisable to ensure that the warranties on your mounting frame match or exceed the warranties of your solar panels and their inverter. The standard mounting frame warranty is 10 years.

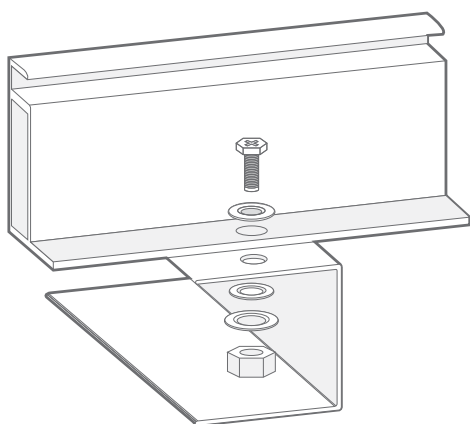

FIGURE 1. FRAME MOUNTING

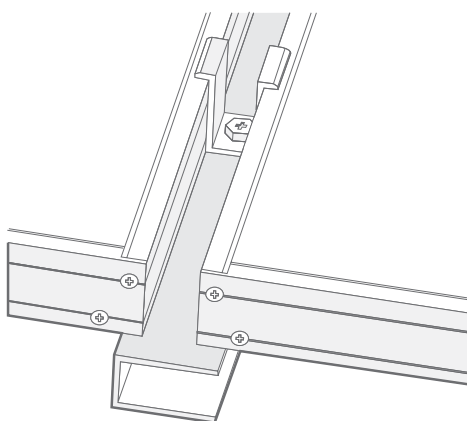

FIGURE 2. CLIP MOUNTING



## METERING YOUR SOLAR SYSTEM

There are two fundamental steps to take when connecting your solar system to the grid

**Step 1.** Your electricity network company will specify what type of meter is required to measure your solar generation and energy consumption. Your LG dealer will be able to explain the details to you. You may be required to pay for the cost of the new solar meter and its installation in addition to the cost of your solar system. Prices can be a few hundred dollars, so you should make sure that the solar electricity meter supply and connection is included in the quote for your new solar system.

**Step 2.** Negotiate a rate for off-set and exported electricity from your solar system with your electricity retailer. This is called a ‘feed-in tariff’ (FIT) and varies by retailer and location. Some electricity retailers may not offer a FIT. If your existing electricity retailer does not offer a solar FIT, you may wish to consider changing your retailer to a retailer who does. Your solar system installer will be able to advise you on who offers the best FIT in your area and assist you with the process.

We recommend you only use quality panels/inverter solutions for long lasting systems

## RATING YOUR SOLAR SYSTEM

Your LG solar system is rated according to the number of watts it can produce per hour. This rating is rarely achieved in full during real life conditions as dust particles, clouds and other natural issues will affect the quality of light that your PV panels receive.

For example 16 x 330W solar panels will create a 5,280 kW solar system. In regards to overall system output on an average day with intermittent clouds this system will produce approximately 3-4 kW per hour in the best sun irradiation hours of the day. The system will only achieve 5kW per hour on a very sunny day, in the middle of the day and clear sky, for example after rain.



\*In 2016 LG panels won the prestigious Top Brand - Australia Award, and Intersolar Award

LG Panels look fantastic on your roof.  
A smart looking home is a more valuable asset.  
Invest in LG panels for better long term outcomes.

LG PANELS

CONVENTIONAL PANELS



## MEASURING HOW YOUR COMPONENTS PERFORM. THE DIFFERENCE BETWEEN KW AND kWh

kW stands for kilowatt or 1,000 Watts and is a measure of power

kWh stands for kilowatts per hour and is a measure of energy

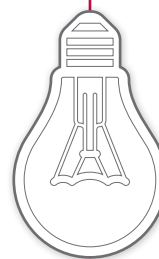

Electricity bills are usually measured in units of kWh. Solar Panels are measured in Watts. E.g. LG Neon 330W

A 1 kW electric pool pump used for one hour will consume 1 kWh of electricity

Twenty x 50W down lights used for an hour will consume 1kWh of electricity (20 x 50 = 1,000)





# INSTALLING PV PANELS FOR YOUR SOLAR SYSTEM

## TILTING AND ORIENTATION

Solar modules can face anywhere from the East to the North and the West, while still providing good output performance.

In Australia, a grid-connected solar system will generate the most solar electricity when the LG solar panels are facing north at a tilt angle of 15 to 30 degrees. But with the introduction of time of use metering by electricity providers in Australia, a north-west or fully western facing solar system may give a more positive financial outcome.

Time of use metering is when energy retailers charge more for their electricity (approximately 45 cents per kW/h or more) in peak usage periods, for example weekdays from 2pm until 8pm. During these times Western facing panels will produce a greater amount of solar electricity, therefore creating better savings.

Discuss with your LG Authorised Dealer your electricity usage, so that your usage pattern can be matched with your solar panel's installation direction.

## DAILY ROUTINE

Thinking about your daily routine and your electricity consumption will help you locate the best possible position for your solar panels. If lots of electricity is used in the morning, an Easterly roof will offer the best benefits. If lots of electricity is used during the middle of the day, we would advise a north roof and if lots of electricity is used in the early and late afternoon a north-west roof is more likely to offer the best outcome. With multi-string inverters you can also put one group of solar panels (one string) on the East and one on the West to cover a wider time-span.



## SHADING

The amount of electricity generated by your solar system directly relates to the amount of sunlight that your PV panels receive. The more your solar modules are covered in shade, the less electricity your system will generate.

Even a single antenna or a chimney shadow on your panels can affect performance, while the overall effectiveness of your solar system is dependent on where you live. In some areas of Australia (for example, the Blue Mountains near Sydney) over 20% of homes have reduced suitability for solar systems due to extended tree coverage close to the home.

Using micro-inverters or power optimisers on each panel, instead of one large string inverter (where multiple panels are connected to one inverter) can help with shadow issues. With each individual panel managed to achieve its maximum electricity output individually, the losses associated to shade can be reduced by as much as 25%.

If you believe that you may have a shadow issue, talk to your LG dealer and check if power optimisers or micro-inverters are a potential solution for your solar system.

## MOUNTING

If a suitable roof area is not available at your home, LG solar panels can be fitted to a ground-mounted system in a sun-filled spot on your land.

However, you will need to allow for additional costs for a ground mounting system, including costs for running the cable safely in the ground. These options can be discussed with your local LG solar dealer.



## INSTALLING PANELS FOR GREAT PERFORMANCE

LG is confident that our panels will give you years of reliable functionality. As of February 2017 only 3 panels have needed to be replaced from over 350,000 panels installed across Australia since 2011. Although the cables, safety devices and mounting systems are less influential to the performance of your solar system, the use of poor quality cables or isolators can lead to premature system failures. In cases where non-branded plugs and cables were used, complete system failures have occurred.

For a decade of low maintenance to your solar system, it is strongly suggested that you purchase high

quality solar panels, quality solar inverters and ask for a quality balance of system components in all aspects of your solar system.

Some cheap solar panels have failed in the Australian and NZ climate in as little as 24 months. Typical issues have been water ingress, corrosion, hot-spots, failed bypass diodes or junction box failures. These type of failures lead to the write off of the panel. Often the lengthy promised warranties are hard to claim when dealers, installers or panel manufacturers have gone into liquidation or have stopped operating in Australia.

Electricity bills are usually measured in units of kWh. Solar Panels are measured in Watts. E.g. LG Neon 330W

Over 520 solar installation companies have gone into liquidation since 2011\*. If you select a LG Authorised Dealer you have an installation company that has gone through detailed vetting by LG.

# HOW MANY PANELS DOES YOUR SOLAR SYSTEM NEED?

An LG Authorised Dealer will visit your home for a site inspection, checking the roof position, discussing your electricity usage pattern, discussing monitor options and, where applicable, conducting a shade analysis to ensure that the right quantity of the right panels are placed in the optimum position.

Buyers should insist that their installation company also undertakes a physical site inspection. Many variables require consideration, with many difficult to spot from satellite images or from photos of your home. An installer's willingness to visit your home gives some indication as to the quality of service you will receive for your purchase. As a result, we strongly advise that you buy your solar system from a local company and not an internet-based solar sales agent.

Historically (when internet solar sales were rapidly increasing) consumers purchased solar systems without site inspections, only to have their installer highlight the need for special roof brackets or a total switchboard upgrade before the solar can be installed. These additions added unexpected costs and time delays to the consumer.

Before making your purchase decision, check who is your point of contact if you have questions after your installation. Make sure that you ask for a comprehensive written warranty from the installation company for the cabling and installation work, not just the panels, inverter and mounting frame.



## HOW LONG SOLAR SYSTEMS LAST

The key components susceptible to failure in your solar system are the solar panels, the inverter and some components like fuses and isolators. This is often because cheap lower quality products have been sold at low prices, but have been made to look like high quality via long "warranties" and other claims.

High quality solar products overall tend to have longer life-cycles as they undertake more quality control steps, use higher quality cells and solders, have stronger UV protection on backing sheets and ensure the water sealing of panels withstands decades of weather induced deterioration. Very low cost panels with less UV stabilised backing sheets, cheaper sealants and more fragile framing can deteriorate faster and some have failed in Australia in as little as 2-3 years.

Cheap inverter solutions also have higher failure rates than quality solutions. Unfortunately often lengthy warranties on cheap products have been unobtainable as both manufacturers and installation company have avoided liability by going into liquidation e.g. Sunnyroo or Aearosharp inverters. In Australia over 520 installation companies have liquidated their business and escaped warranty obligations since early 2011\*.

The key warranty for solar panels is the Manufacturer's Warranty. High quality panels cover transport of the replacement panel, the replacement panel and the labour to take the failed panel down and replace it. Cheaper panels often do not cover transport and replacement labour. Make sure you enquire what is covered in the warranty and ask for the detailed warranty document. Standard Manufacturer's Warranties are usually for 10 years, and for LG panels it is 12 years.

# SOLAR PANEL SIZES



FOODBANK, WESTERN SYDNEY, 250kW LG NeON® 2 SYSTEM

## SOLAR SYSTEM SIZE GUIDE



### SMALL HOME

  1-2 People  
**2kW System**  
 Av. production per day: 8 kWh

### MEDIUM HOME

  2-3 People  
**3kW System**  
 Av. production per day: 12 kWh

### LARGE HOME

  4+ People  
**5kW System**  
 Av. production per day: 20 kWh

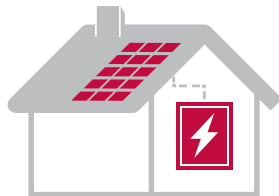

Capacity of solar power system with 20 modules (60 Cells)

**6.6**  
kWp  
330W NeON®2

**6.0**  
kWp  
300W Mono X Plus®2

**5.2**  
kWp  
260W Polly Standard Panel

## WHY PANEL EFFICIENCY MATTERS

A few years ago many buyers of residential solar did not consider the efficiency of their panels. If they wanted a 5kW system they could buy 20 panels with 250W or 23 less efficient 220W panels. Most customers never imagined they would in the future need more than 5kW of solar and in many homes around 20 to 32 panels will fit on the roof. That was the old solar.

But with the emergence of battery storage as a smart way to harvest the light during the day and then to use this electricity at night, panel efficiency has become a very important consideration. Considering that the future of electric cars is coming fast, with Volkswagen for example announcing many electric car models in a few years; you might want to expand your solar system in the future to power the electric car.

The worldwide CO<sub>2</sub> reduction could be enormous if we are able to utilise our roofs to generate some of the fuel for our cars. In short in the future one might want 4-5kW of solar system

for day use and 1-2kW of solar for the batteries to use at night and then to fuel the car one would need another 4-6kW of solar to power the car(s) via solar. Overall suddenly there is the need for a 10 -12kW system. With 260W panels this would mean one needs to fit at least 40 panels. On the other hand, with the highly efficient 300W & 330W LG panels one would need only 34/32 panels.

LG in early 2017 is releasing a 350 to 360W most high efficient 60 cell panel called NeON R, followed by a 400W panel in future years. This means if you can save 8 spots now, with a higher efficient panel – you can have another 3.6kW solar system for your batteries or cars, which you would not be able to fit otherwise.

So it is important today to buy a system with future expansion capability in mind, both for batteries and future Electric Vehicles.

Buy now with the needs of the future in mind. Choose high efficient panels and save roof space for future expansion.

# INCENTIVES, REBATES AND FINANCING

## ARE THERE REBATES AVAILABLE FOR YOUR SOLAR SYSTEM?

Rebates may be available for your solar system. Over the years these rebates have changed and may continue to change in the future. Talking to your nearest LG installer or visiting the Clean Energy Council website will give you updated information about the latest rebates applicable to you.

There is currently one key rebate offered for solar PV systems in Australia called Small Scale Technology Certificates (STCs). As per February 2017, this rebate offered around \$3600 towards a 5kW system, but the rebate amount can change from time to time. When you see advertised sales prices for solar systems, these prices usually have subtracted the rebate from the full price. The rebate will reduce every year in January, for the next few years.

## WHAT ARE STC CERTIFICATES?

The savings of CO<sub>2</sub> emissions via solar electricity generation is rewarded through tradeable certificates for small scale solar systems called Small Scale Technology certificates or STCs.

When your solar system is installed you can complete a calculation to confirm how many STCs will be created over the life of your system. This is effectively a measure of the renewable energy generation from your system.

Solar system installation companies typically offer an up-front discount equal to the value they will receive when they sell your STCs. What this means, is that the STCs for your system are handed over by you to the solar system installation company in lieu of some form of payment for your system. The solar system installation company then trades the certificates and receives a cash return. Most customers treat their STCs like a rebate with their value deducted from the sale price of their solar system. It is important to understand several key aspects of these STCs:

- The Government does not pay you for certificates, nor does it set the price;
- As of February 2017 a 5kW solar system attracts a rebate ranging from \$3200 to \$3600, but as a tradeable certificate, STC value can and does vary over time and is not fixed;
- The quantity of STCs you may receive for a system varies depending on your location and when you create them;
- Suppliers who agree to offer you a price for STCs must comply with certain rules and conditions set out by the Clean Energy Regulator and only approved companies may register and trade STCs

## ZERO DEPOSIT PAYMENT PLANS

Consumers also have the option to finance a solar system. Often homeowners redraw on their mortgage to finance the solar and battery system. Your installer can advise you about other available finance options.

## WHAT ARE FEED IN TARIFFS?

Feed-in tariffs (FIT) are a defined payment for the electricity you generate from your solar system that is sent back to the grid. Currently energy retailers in most States pay relatively low FIT ranging from 5-12 cents. These FIT rates are based on state guidelines and vary between electricity retailers. We recommend shopping around between retailers to determine the best available FIT rate for you.

Some Energy Retailers sell solar systems and will tempt you with a high FIT. Please check that the overall electricity charges in such contracts are not higher than normal kWh charges, as your higher FIT income may be more than offset in higher electricity fees and charges.

Previously, Australian solar system owners have benefited from a range of generous "premium" FIT schemes. Unfortunately, these offers are no longer available with new solar installations.

The value of a FIT is an important aspect to consider as it can influence the economic outcome of owning a solar system and what the ideal size of a system should be in your individual case. Good solar installation companies as part of their site visit should offer a detailed analysis of what they expect your self-consumption to export ratio to be, and what economic outcome you will be able to achieve.

Naturally if you install batteries with your solar system the FIT is less relevant.



## DETAILS ON HOW TO CHOOSE A SOLAR COMPANY

It is recommended to use a reputable installation company that checks your specific solar system requirements. Please see the points below regarding the advantages of using a company promoting high quality products.

- ① A reputable solar retail company is more likely to fully evaluate your requirements and explain in details what needs to be done in order to install your solar system.
- ② A local diversified company is more likely to be around in the future to service any warranty issues or system upgrades. With some loud, marketing and price focused solar companies longevity of the company can be an issue. For example, in Australia since 2011 over 520 solar companies have gone into liquidation\*.
- ③ If your installer is selling you LG solar panels, then in future years LG is very likely to be able to have a local company service your LG panels. If you choose an unknown brand, the manufacturer may go out of business or the importer may stop importing these panels into Australia. It is recommended to buy branded solar panels from diversified manufacturers like LG with warranties that actually have a meaning.
- ④ A reputable solar company will be fully aware of current electricity supply rules as well as provide you advice on the best feed-in-tariff. As a result, well established business will be able to give you the most up-to date advice.
- ⑤ If your local installer belongs to the authorised LG installer network, then he/she has to install the solar power system to a high standard and act ethically in their business dealings with you, the customer.

All systems installed in Australia have to be signed off by an accredited solar system designer/installer. The following elements are considered when designing a solar system:

- a. The available roof space and optimum panel location;
- b. The orientation and pitch of the roof(s);
- c. Impact of shading across all seasons and time of day;
- d. The structural soundness of the roof;
- e. Sizing the strings of panels for the correct voltage of the inverter solution;
- f. Ensure the design meets building codes and electrical standards;
- g. Determining the most suitable location for the inverter and the way the cables are run;
- h. Considering appropriate monitor options and consider if batteries are appropriate.

\*Source: ASIC liquidated companies register

# QUESTIONS TO ASK BEFORE YOU BUY

Asking your solar installer a few essential questions may make a big difference to the service and benefits you receive. Make sure you get the answers in writing.

- 1 What is the estimated monthly and annual production in kWh of my system in its installation position?
- 2 What is the estimated solar electricity production in the best and worst months? See the LG output calculator on [www.lgenergy.com.au](http://www.lgenergy.com.au)
- 3 Who will service and maintain my solar system? Get an address and contact details, preferably of someone reasonably local.
- 4 What are the responsibilities of each party? Include the installer, manufacturer and consumer.
- 5 Who is responsible for connecting your solar PV system to the electricity grid? Is it the installer or another subcontractor? When will it happen?
- 6 Who is responsible for your meter change? Make sure this is clarified. Quality installation companies usually offer to accommodate the whole job.
- 7 How the installer will credit your solar rebate (STCs)?

## WHAT YOU SHOULD KNOW ABOUT THE 25 YEAR OUTPUT "WARRANTY"

Over time solar panels will show degradation and produce each year a little less electricity. In order to give purchasers some guidance about the level of degradation, an Output Warranty is offered by most manufacturers. This Output Warranty goes in most cases for 25 years and guarantees that for conventional panels an output of around 80% of initial production efficiency is still maintained by the panel (LG offers 84.8%).

Unfortunately, this "Warranty" can easily cause confusion. Please note an Output Warranty IS NOT a Manufacturers Warranty on the actual panel. For example, if in year 13 your panel fails completely, then the Output Warranty may not cover the faulty panel. A panel has to be in working order to claim an Output Warranty.

In many sales promotions the 25 YEAR Warranty is highlighted but when you read the details of an Output Warranty, you will have to pay for getting panels off the roof, shipped for testing and then also pay for the return and reinstall.

Often the compensation for a poor performing panel is less than \$100, when the customer had to spend many hundreds of dollars on install/uninstall and on the process to show the output of the panel is poor. Therefore this warranty only has a low value. Be aware of glossy 25 Year Warranty stickers – it is the 10 or 12 year (LG is 12 years) Manufacturer's Warranty not the Output Warranty that counts.



It is also important to get in writing the various component warranties including installer workmanship guarantee, schedule of when deposits and progress payments are due.

# ADDITIONAL TIPS TO AVOID THE SOLAR SHARKS AND POOR QUALITY SOLAR EQUIPMENT

Unfortunately, as in any industry, some unscrupulous operators can affect the reputation of professional, positive and reliable suppliers. Please see the helpful hints below to give you a positive solar experience.

1. Undertake some solar research via our Frequently Asked Questions (FAQs) on [lgenergy.com.au](http://lgenergy.com.au)

2. Do your research about brands and prices. There are some very cheap offers in the market, but these cheaper deals can hide poor quality equipment that are made to appear like quality products. You are looking for a product that lasts 25 years so that your financial investment is repaid over and over. Find out about the company offering the very cheap deal. For internet research try Whirlpool – the Green Tech section: <http://forums.whirlpool.net.au/forum/143> or the facebook group “Crap Solar”

3. Do not give into pressure selling and deadlines. It's one of the oldest sales tricks in the book. If the sales person cannot give you the time to make a considered decision, then what are they fearful you will discover about the deal if you spend some time doing a bit of research? If the company has just come into town for a solar deal, they will be gone after the install and you will be left to your own devices. Please buy from reputable solar companies. In years to come you might need their solar expertise and support.

4. How big is your roof and how big a solar system can it fit? Try our roof size calculator to work out how big your solar system can be on your specific roof. To check the calculator results contact your local LG dealer. Remember to allow some reserve space for when you install a solar storage battery for night time solar power use, and then again for more battery storage capacity to charge up an electric car in future years. Your quality solar system is built to last 25+ years. Go back 25 years to the days of 'brick' mobile phones, dot matrix printers

and ghetto blasters to consider what the next 25 years may herald and how your home power needs may grow.

5. Solar systems vary in quality and size and so does the price. Set yourself a budget. As a rule of thumb each kW of a quality solar system will cost in the range of \$1,500 to \$1,700 for a residential system up to 10 kW. You will find a system for \$800 to \$1,000 per kW but you are looking at lower grade systems with less output productivity and shorter working life. This may cost you more in the future in repairs and replacements. Use your rebate wisely. You are making a 25 years or longer investment, so please consider quality and real warranty support over everything else. And remember a solar system with a good brand name and performance at the time you sell your home may increase your property value.

6. Panel Types & Certifications: We recommend the high efficiency mono-crystalline solar panels, as this is the technology used most often in quality solar systems in the world today. It is also the most tested technology, as mono-crystalline panels have been mass produced since the 1970s. They have a black appearance and from our point of view will aesthetically blend in more to your roof and neighbourhood than the blue multi-crystalline solar panel variety.

7. Solar systems attract government rebates if they have been registered with the Clean Energy Council. You should check with the install companies if the offered panels are registered (most are nowadays). All LG panels are registered and have completed extensive fire resistance testing, a latest requirement (introduced in mid-2013) in the Australian Solar standards.

8. Manufacturer's Warranty: Many manufacturers will offer 10 years' manufacturing warranty and an 80% output efficiency warranty at 25 years. For a normal consumer it becomes difficult to separate the wheat from the chaff. Companies like LG offer full parts and labour warranty and a replacement warranty. Finally make sure that the manufacturer has a local legal entity in Australia. Should you have a dispute in years to come, a company with no link and contact in Australia is hard to communicate with when it comes to consumer rights.

9. Choose a quality Inverter solution to go with quality panels: An inverter is the heart of your solar system. It will have a direct impact on the efficiency of conversion from solar power to usable electric power of your system. The more efficient the inverter solution, the better the energy conversion process will be. The bigger and more established the manufacturer, the more likely warranty claims or required repairs will be dealt with smoothly.

10. Mounting & Accessories: There are building standards for every aspect of the mounting and electrical accessories used in a solar system. Quality systems are certified. Ensure that the installer uses the certified product by getting the products used in your system listed as part of the quote.

11. Quotes & Buying: Do not get pressured by sales persons to sign a deal then and there. Avoid the traveling band of solar installers hitting town and then disappearing, never to be seen again. Use reputable and established business to install your solar system.

**Happy Solar research.**





We have been involved in the solar industry since 2007 and over this time we have concentrated on sourcing quality solar product suppliers that have a long history and a bright future in the solar industry. This means that when you buy solar from South Coast Solar Solutions you are guaranteed that you will be using high quality solar products such as LG, SMA and Power One.

Initially servicing the Shoalhaven and Illawarra regions, our business grew on the back of being a supplier of reputable brands combined with honest and reliable service. We have now expanded into Sydney and the far south coast while still offering the same strong customer focus that has seen the business grow over the past years.

Specialising in solar and energy saving products, we offer professional and honest advice, free site inspections and system design services. No two homes are the same, that's why we take the time to visit every customer at their home to tailor a solar power system to suit their particular electricity consumption patterns. By going through this detailed auditing and electricity usage analysis we ensure that our recommended solar power system will be custom designed and will maximise your return on investment. Our solar services include solar electric power, solar hot water, pool heating, energy saving products and rainwater tanks.

At South Coast Solar you will deal only with fully accredited tradesmen to complete your solar system installation. We are a local company, employing local people and striving to ensure all our customers get the quality and value they deserve. Speak to our friendly and courteous staff now to arrange a free site inspection and quote. You can also find out more via our website on [www.windsolarenergy.com.au](http://www.windsolarenergy.com.au). We install approximately in a 80km radius from Bomaderry in areas such as Picton, Appin, Tahmoor, Bargo, Woonona, Mittagong, Wollongong, Bowral, Moss Vale, Port Kembla, Towrang, Marulan, Bawley Point, Kangaroo Valley, Cambewarra Village, Nowra, Kiama, Shellharbour, Dapto, Primbee, Minnamurra, Huskisson, Vincentia, Mollymook, Ulladulla and more.

**South Coast Solar Solutions**  
**[www.windsolarenergy.com.au](http://www.windsolarenergy.com.au)**  
**Michel Orford**

Telephone: (02) 4422 4155

Mob: 0423 870 727

Fax: (02) 4422 4155

Email: [sthcoastsolar@gmail.com](mailto:sthcoastsolar@gmail.com)



# 30 LG PANEL ADVANTAGES AND THEIR BENEFITS FOR YOU

A solar panel harvests the sun and converts it into electricity and is together with the inverter the most important part of a solar system. A solar system only achieves a positive return on investment after a number of years. Contrary to some cheap panel sales spin, the fact is - Not all solar panels are built equal. Given that a solar panel is exposed to wind and weather and has to endure many temperature variations, while producing electricity, the built quality of a solar panel is very important.

With non branded cheaper panels, even within one manufacturer there are variations in built quality, depending on the destination of the product and the originating factory. LG panels all come from one factory in Gumi, South Korea and there are no variations as to the built quality meaning our panels shipped to Vietnam or Indonesia are the same as the ones exported to Germany, Japan, the US or Australia.

Choosing long lasting, high efficient LG solar panels and quality inverter solutions will ensure you will have a long lasting trouble free system. Longer lasting systems will provide a higher financial return than cheaper, poor quality systems, which in Australia have failed by the thousands after only a few years in service. So while LG panels initially cost more than some non-brand competitor panels over the life of the system LG panels can create one of the best financial and environmental results for you.

## Great Visual Appearance

### ① Great looks for your roof

LG Mono X Plus and NeON<sup>®</sup> 2 panels have been designed with appearance in mind. Their black cells and glossy black frames give an aesthetically pleasing uniform appearance. Standard competitor poly panels have blue cells and plain aluminium frames. For very aesthetic conscious customers LG is also offering a stunning looking complete black version of their NeON<sup>®</sup> range.

**YOUR BENEFIT:** Ensuring you have panels that are high quality, attractive panels and make your roof look great and may preserve or increase the resale value for your home.



LG Mono X<sup>®</sup> Plus



LG NeON<sup>®</sup> 2 Black

Why LG panels lead the pack

## Higher Performance through winning technology

### ② Proven field performance

LG and other companies, including the Australian consumer organisation Choice have been involved in a number of comparison tests of the LG modules against many other brand panels. LG Mono X<sup>®</sup> and NeON<sup>®</sup> 2 panels are consistently one of the highest performing panels in these tests. In the Choice test conducted between October 2015 and October 2016 the LG NeON<sup>®</sup> 300W won against 15 competitors as the highest output per watt panel.

**YOUR BENEFIT:** Improved performance in all weather conditions.



### ③ Double sided cell structure for NeON<sup>®</sup>2 panels

The LG NeON<sup>®</sup>2 panel produces energy from both the front and the back of the cell. This innovative approach allows the absorption of light from the front and the back of the cell, which raises the panel's performance. The LG NeON<sup>®</sup> panel is the only panel in Australia offering this feature. In 2013 LG won the Intersolar Award in Germany for this innovation. Other NeON<sup>®</sup> panel innovations also won further Intersolar Awards in 2015 and 2016.

**YOUR BENEFIT:** Additional electricity generation from light hitting the edge and back of the solar cell

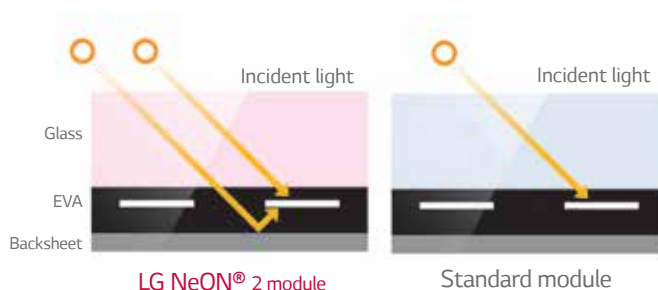

### ④ Maximising roof space for future expansions (More power per square Metre)

LG Mono<sup>®</sup> X Plus and NeON<sup>®</sup> 2 panels are rated at 300W and 330W per panel, whereas many conventional panels achieve only a 260W rating. This equates to 15% more power from LG Mono<sup>®</sup> X plus and 26% more for the NeON<sup>®</sup> 2 panel than many 260W panels that are the same physical size.

**YOUR BENEFIT:** You use less roof space for a given system capacity and/or have room for future system expansions for batteries and even electric car charging in years to come.

## Higher Performance through winning technology

### 5 12 wire busbars ("CELLO" Technology Increases Power) with NeON<sup>®</sup> 2

LG's "CELLO" Multi wire busbar cell technology lowers electrical resistance and increases panel efficiency, giving more power per panel and providing a more uniform look to the panel. In 2015 LG won the Intersolar Award in Germany for this innovation.

**YOUR BENEFIT:** Higher electricity output than conventional panels in all weather conditions and latest technology ensures your panel stays relevant in future years.

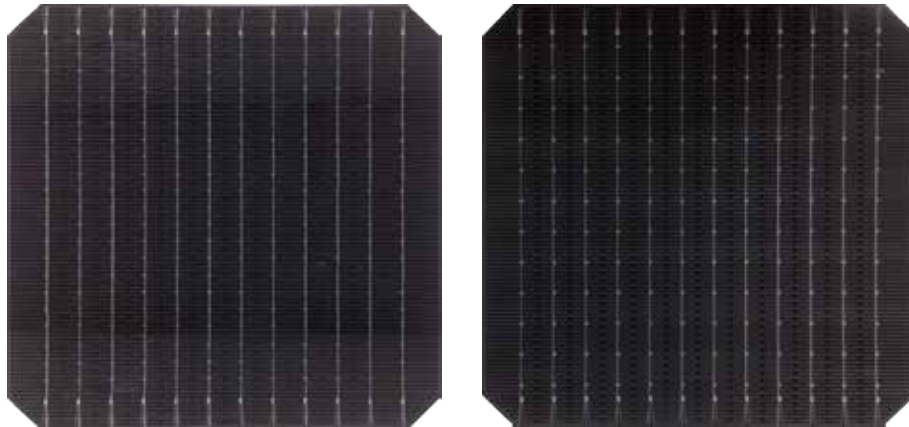

Front and rear of NeON<sup>®</sup> 2 cell

### 6 Lower degradation than industry standard

Solar panels degrade over their lifetime and produce less electricity each year. LG has reduced the al degradation of our Mono X plus panels by applying our new LiLy (LID- Improvement for lifetime yield) Technology, which controls the reaction of Boron and Oxygen, a key factor in light induced degradation (LID). The NeON<sup>®</sup>2 also has a very low LID, due to the use of N type treatment of the cells which uses phosphorous as a replacement for Boron.

**YOUR BENEFIT:** Less degradation of electricity production than conventional panels as the panel ages.

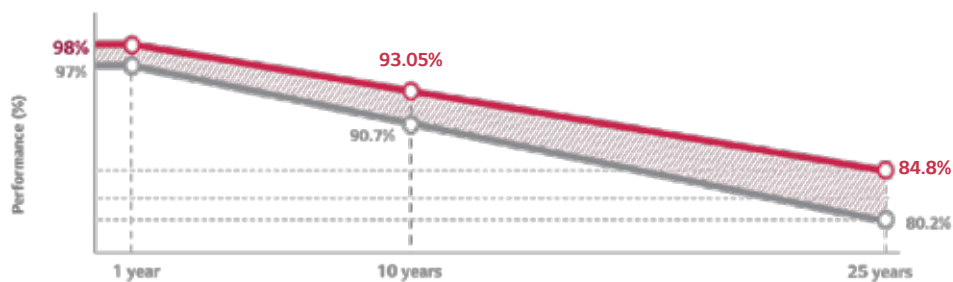

### 7 Anti-reflective coating increases output

LG is using an anti-reflective coating technology on the glass and on the cells of our panels to ensure more light is absorbed in the panel and not reflected.

**YOUR BENEFIT:** More absorbed light means more electricity generation.

### 8 Improved High Temperature Performance

Solar panels slowly lose ability to generate power as they get hotter. One a very hot summer day panels can be as hot as 70 degrees which means for many panels a performance loss of over 20% over a panel that is only 25 degrees hot, on a milder day. LG Mono X plus and NeON<sup>®</sup>2 have one of the best temperature performance characteristics, which means even in very high temperatures our panels will deliver higher output than standard panels.

**YOUR BENEFIT:** Better performance on hot days than most conventional panels means more power generates to use to run air-conditioning, pool pumps and fans for example.

## Higher Performance through winning technology

### 9 Excellent low light performance

Great performance under low light conditions due to LG technology and our own cell manufacturing with low tolerances, ensuring highly consistent performing panels. At 200W/m<sup>2</sup> LG panel efficiency drop is -2% while many conventional panels reduce by -4%.

**YOUR BENEFIT:** Better performance on low light days including cloudy or early morning/late afternoon, the time when performance really counts.

### 10 Multi Award Winner

LG panels have won numerous awards over the past year. For example the NeON® panel range has won the Intersolar Award for Photovoltaic Innovation in Germany, three times since 2013. The LG solar brand has won the “Top Brand” in Australia Award in 2017 and 2016 and the Top Brand for many countries in Europe in 2017, 2016 and in 2015.

**YOUR BENEFIT:** Panels have been recognised as innovative and cutting edge by industry experts giving you confidence in the quality and performance of the product.



## Peace of mind warranties

### 11 Diversified manufacturer– stable and strong warranty

In mid 2016 there were over 220 panel manufacturers with panels registered for sale with the Clean Energy Council in Australia. It is likely that in future there may be a significant consolidation of solar manufacturers taking place with potentially only a fraction of these manufacturers operating in Australia long term. LG with its diversified manufacturing, strong bankability, diversified product portfolio and its multi-billion dollar size has a better opportunity than many others to be a leader in solar in decades to come.

**YOUR BENEFIT:** A peace of mind, strong warranty.

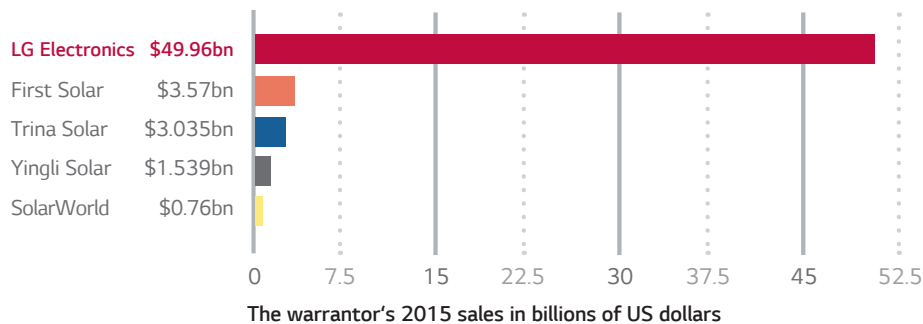

### 12 Twelve (12) year parts and labour manufacturer's warranty

LG offers a 12 year parts and labour warranty which includes the cost of shipping panels as well as the labour cost of un-installing and re-installing the panel, compared to the 10 year manufacturer's warranty offered most other manufacturers, which is the current industry standard.

**YOUR BENEFIT:** You get a longer warranty than many other panels on the market (12 yrs v 10 yrs).

Also as the majority of conventional panels do not cover labour and/or transport for replacement panels.

LG has also developed a detailed customer friendly warranty brochure to help you, should there ever be a claim.





LG invests heavily into solar research.

### 13 Warranty registration with LG Australia/NZ

LG offers a simple warranty registration process via [lgenergy.com.au](http://lgenergy.com.au) in Australia and New Zealand.

**YOUR BENEFIT:** LG has a record of your purchase details in case of a warranty claim.

### 14 Tier 1 Ranking by Bloomberg New Energy Finance

LG panels have been recognised by Bloomberg New Energy Finance as a Tier 1 Solar Manufacturer. The Bloomberg Tier 1 ranking is widely recognised within the industry as a measure for bankability of the manufacturer. It does not reflect built quality or longevity of the panels. Other manufacturers sometimes use the Tier 1 label as a sign of built quality or financial stability of the manufacturer – which IT IS NOT.

**YOUR BENEFIT:** Being a Tier 1 panel along, does not guarantee a long lasting panel. It is the combination of many manufacturing aspects as demonstrated in these pages, that bears witness to LGs excellent solar panel quality.

## Quality built and testing for better reliability

Not all solar panels are built the same, and many struggle to achieve the LG build quality. In Australia & NZ some cheaper modules have failed in as little as 2-3 years. Reasons for failures and low output performance include hot spots, corrosion, water ingress, failed bypass diodes, poor sealants, delaminations and micro cracks.

### 15 Cyclone wind load resistance

LG modules have a strong double walled frame. When it comes to wind forces (rear load) many competitor modules are certified to 2400 Pascals. LG modules are certified to more than double, 5400 Pascals, making them very sturdy and one of the strongest on the market.

**YOUR BENEFIT:** Less likely issues with panel failure in extreme wind conditions and wind load exposure over many years.

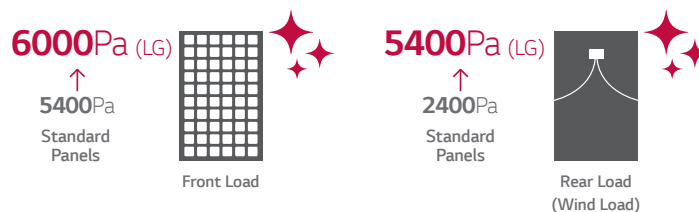

### 16 Extensive testing program - up to 4 times international standard

One of LG's specialties is their focus on testing. In order to be sold in Australia solar modules have to be tested and pass the IEC standard tests once. LG solar panels are regularly tested up to 4 times the IEC standards by LG in-house testing laboratories. LG also chooses to spend a significant amount of money on research and development. In fact, 25% of their entire solar focussed workforce is dedicated to discovering new technologies and improving their solar technology.

**YOUR BENEFIT:** Confidence in the product and ensuring a very robust and longer lasting solar module.

17

### Lightweight but strong

Even though LG panels having high wind stability, our 60 cell panels at 18kg are lighter than most of the competition panels.

**YOUR BENEFIT:** Less weight and stress on your roof structure, especially for larger systems.

18

### High quality components

Our LG panels use quality junction boxes which are completely water proof (IP67) and use the original Swiss MC4 panel connection plugs, not copies, like some lower priced competitors do.

**YOUR BENEFIT:** Confidence in the product and ensuring a very robust and longer lasting solar module.

19

### Fully Automated production line

LG panels are manufactured in Gumi, South Korea in a fully automated factory. The wafers, cells and panels are manufactured in one seamless process production line, which emulates the air purity of semi conductor manufacturing environment.

**YOUR BENEFIT:** A consistent and high quality solar product.

20

### Premium quality control on input materials and production

LG controls its supply chain very thoroughly to ensure a consistent and high quality solar module. During the fully automated standardised manufacturing process very low variation tolerances are allowed during the 500 quality control processes.

**YOUR BENEFIT:** A consistent and high quality solar product.

21

### Anti PID technology for yield security

PID (Potential Induced Degradation) has been a more recent discovery that can affect the long term performance of the panel. LG panels are manufactured with anti PID technology and have been extensively tested by leading third party testing laboratories regarding PID and passed these tests.

**YOUR BENEFIT:** This means LG panels are more likely to give decades of clean power.

22

### Positive tolerance (0/+3%)

If we sell you a 330 Watt rated solar panel then the flash test of this panel will show at least 330W and can be up to 339.6W. Some competitor panels have -/+ tolerance, so you could get a flash test result below the rated Watt, (e.g. a 250W panel may really only be 243W) meaning you pay for Watts you never get.

**YOUR BENEFIT:** Every Watt you pay for is delivered with LG solar, plus a little more.

23

### Passed fire test

All LG modules have passed fire safety tests and contain flame retardant materials, meaning should any electrical malfunction occur the panel will not combust and catch fire, as required by Australian registration regulation.

**YOUR BENEFIT:** Safety for your home.



## 24 High compatibility with all quality inverter and racking solutions

LG modules are designed for residential, commercial and utility scale systems. The panels will work with all inverter and micro inverter solutions on the Australian and NZ market. The panels can be mounted for roof top or ground mount in vertical (landscape) and horizontal (portrait) installation position.

**YOUR BENEFIT:** Maximum system design flexibility, allowing a bigger system to be installed in some roof situation, due to landscape install option.

## 25 Micro crack testing

Two EL "flash" tests are performed on the LG module during production to ensure no cells with microscopic cracks are used. One test is conducted before lamination and one after lamination. An image of each micro crack free panel with serial number is stored in LG's database in case of any future warranty claim.

**YOUR BENEFIT:** A well built module without microcracks leaving the factory.

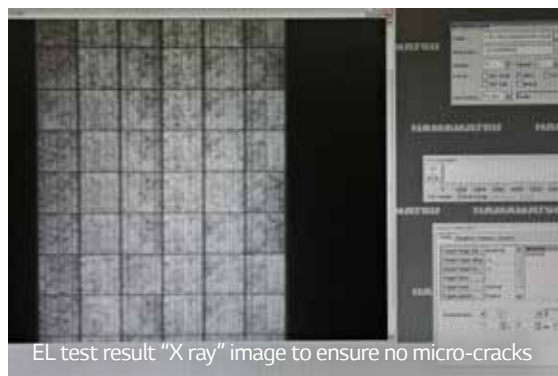

## 26 LG Testing Laboratory Certification

LG has had its internal testing facilities certified by 4 major international testing laboratories (VDE, UL, TUV Rheinland and Intertek) and to ensure the ongoing accuracy reliability of the internal testing processes. This is a first within the solar industry.

**YOUR BENEFIT:** Shows LG commitment to producing panels of uncompromising quality.

## Environmental leadership

### 27 Lower energy payback time

Energy payback is the time it takes for a solar panel to generate the power it took to manufacture, ship and install the solar system. LG has calculated the embodied energy in an LG solar panel as 297.65kg of CO<sub>2</sub> from resourcing of raw materials, to manufacture, and including transporting and installing product. In Brisbane, Australia, the average energy payback of a 330w NeON<sup>®</sup> 2 for example is under 1 year, 5 months as opposed to a standard 260w panel which is close to 2 years. Because LG panels are also built to last long, this means each LG panel can create more clean energy during their working life.

**YOUR BENEFIT:** Higher environmental benefits via LG panels in regards to CO<sub>2</sub> abatement compared to less efficient panels which use the same amount of raw materials.

### 28 Recognised Sustainable Leadership

LG was awarded 44th of the 100 most sustainable corporations in the world by Corporate Knights for 2016, up 7 spots from 2015. Corporate Knights uses a comprehensive measurement system to gauge the Sustainability of a company based on both environmental and societal outcomes. LG are also rated in the top 10 of the Silicon Valley Toxic coalition scorecard for Sustainability and Social Justice.

### 29 No Ozone depleting gases in manufacturing process

LG Electronics runs a Homogenous Substance Management system to ensure that no ozone depleting substances are used in the manufacturing of the panels, or any of the materials supplied to LG for manufacturing of the solar panels.

### 30 LG panels part powering the Solar Factory

LG has installed a 3.2MW of solar power (over 11,000 panels) on the roof of our solar factory in Gumi, South Korea to generate some of the electricity to manufacture the panels. Since 2014 LG has installed over 18MW of Solar panels across its manufacturing facilities across Korea including electrical appliance and battery factories.





Solar factory, Gumi, South Korea with LG solar panels on the roof.



#### STATE OFFICES

##### Queensland

23 Terrace Place, Murarrie, QLD 4172

##### Victoria

3 John Deere Court, Derrimut, VIC 3030

##### South Australia

162 Richmond Rd, Marleston, SA 5033

##### Western Australia

18 Baile Road, Canning Vale, WA 6155

##### New Zealand

60 Highbrook Drive, Highbrook Business Park, East Tamaki, AKL 2013

For further information please see: [LGenergy.com.au](http://LGenergy.com.au)

#### HEAD OFFICE

2 Wonderland Drive, Eastern Creek, NSW 2766

#### CONTACT

Email: [solar.sales@lge.com.au](mailto:solar.sales@lge.com.au)

Enquiries: 02 8805 4000 (Australia)